

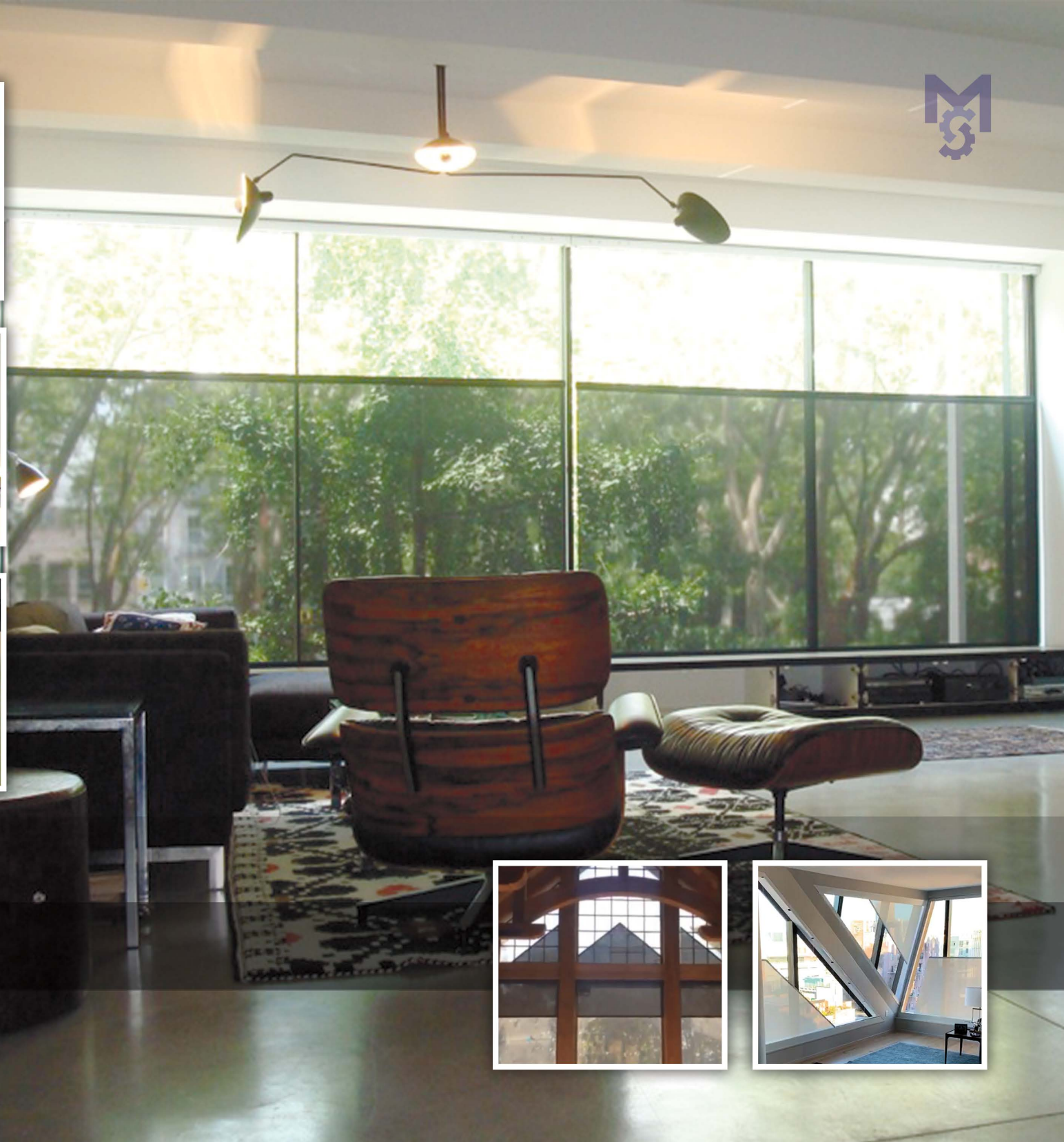

Specialty Systems Guide
INNOVATIONS IN SHADING SYSTEMS

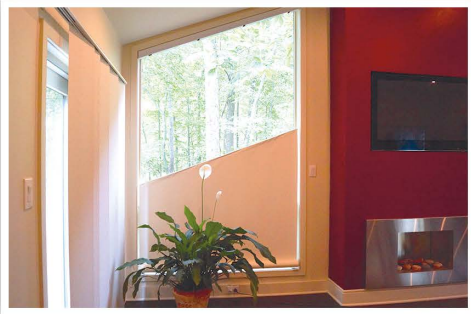

Innovations
IN SYMMETRY





ROLLER SHADES



BLINDS

DRAPERY



HONEYCOMB

ROMANS



SKYLIGHTS

BOTTOM-UP



SPECIALTY

Innovative
PRODUCTS

ANGLED ROLLER SHADES



Years of research and development by our shade craftsmen have resulted in an award winning bottom-up, angled, roller shade system. The shades fully retract to expose the glass and architectural features of your angled, trapezoid, and pyramid shaped windows. They are truly a one-of-a-kind solution.

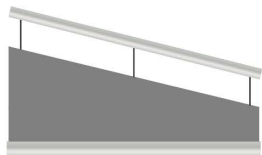

BATTERY SIZE LIMITS - Limited Availability. *Contact customer service for details.*
WIRED SIZE LIMITS: 132" x 144" *Larger Sizes May Be Available*



ANGLED CELLULAR SHADES



Our angled motorized cellular shades are hand crafted to custom fit each unique window. The system mounts at the top angled portion of the opening, fully retracting to expose the architectural features of your window. They are energy efficient in both cold and warm climates. Their honeycomb-like design traps air in distinct pockets, providing insulation to lower your energy consumption and assist with the efficiency of your home. Fabric options range from sheer to blackout. Cellular shades are an optimal choice for an energy focused design.

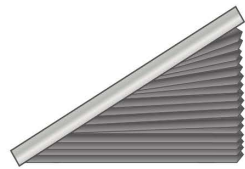

BATTERY SIZE LIMITS: 60" x 60" *Larger Sizes May Be Available*

WIRED SIZE LIMITS: 60" x 60" *Larger Sizes May Be Available*



STRAIGHT BOTTOM-UP ROLLER SHADES



Bottom-up shades provide privacy while allowing natural light to illuminate the room. They deliver function to areas where privacy is a factor and furnish a beautiful aesthetic.



BATTERY SIZE LIMITS - Limited Availability. *Contact customer service for details.*

WIRED SIZE LIMITS: 180" x 180" *Larger Sizes May Be Available*



MOTORIZED SKYLIGHT SHADES



Motorized skylight shades are available in a variety of different systems including our exclusive cellular skylight system featuring one of the only “no visible cord” skylight shades in the industry.

Motorized skylight “**rolling shades**” are available in a wide range of color and opacity options including sunscreens, light filtering, and blackout fabrics. Our sunscreen fabrics block up to 99% of UV and heat without impairing the view of the room.

Motorized skylight “**cellular shade**” systems allow many fabric options. You can provide a pattern and color from any major shade manufacturer, send us your existing shades, or choose from our collection of fine fabrics.



SKYLIGHT ROLLING/ROLLER SHADES

BATTERY SIZE LIMITS: Limited Availability. *Contact customer service for details.*

WIRED SIZE LIMITS: 96" x 120" *Larger Sizes May Be Available*

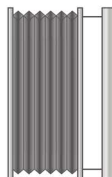

SKYLIGHT CELL SHADES

BATTERY SIZE LIMITS: 60" x 60" *Larger Sizes May Be Available*

WIRED SIZE LIMITS: 60" x 60" *Larger Sizes May Be Available*



ARCHED ROLLER SHADES

Our arched roller shades are hand crafted by our shade artisans to custom fit the curvatures of your window. The shade rises from the bottom to fully cover the radius of the opening.

Roller shades feature a vast collection of soft, touchable fabrics in intriguing textures, weaves, and colors ranging from traditional to contemporary.

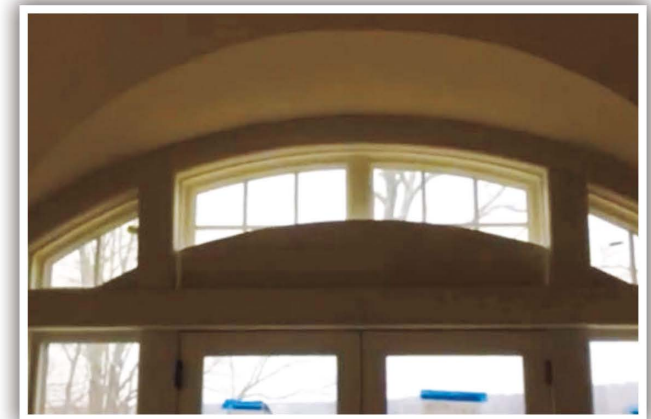

BATTERY SIZE LIMITS - Limited Availability. *Contact customer service for details.*

WIRED SIZE LIMITS: 84" x 84" *Larger Sizes May Be Available*



MOTORIZED ROMAN AND WOVEN SHADES



Roman shades are constructed using fabric and woven wood materials to provide a fluid, sculpted, soft line to accent any décor. They are available in an abundance of styles, pleats, and patterns. Roman shade materials are available in fabric, faux, grass, wood, bamboo, thatch, and natural fibers.



MOTORIZED DRAPES

Draperies provide a timeless solution for your window covering requirements. They offer a soft, decorative accent to your room. Draperies are available in an endless variety of fabric designs and opacities. From heavier materials that offer an insulation value to sheer fabrics that gently reduce the ambient light, there is a drapery fabric that will meet your design needs.

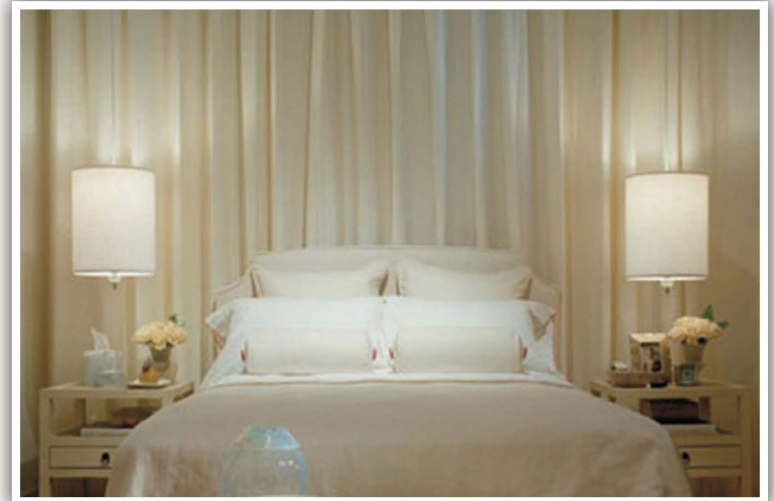

RECESSED DRAPERY TRACK CAVITY



DTC has been engineered for function.

The system provides a perfectly contoured recess for your motorized drapery track and allows for a true, uninterrupted, floor-to-ceiling drapery.

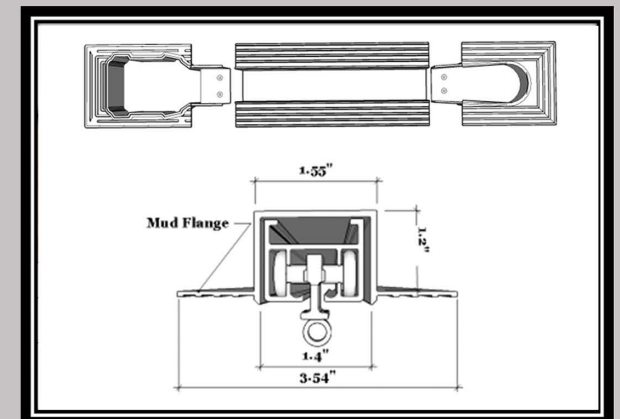
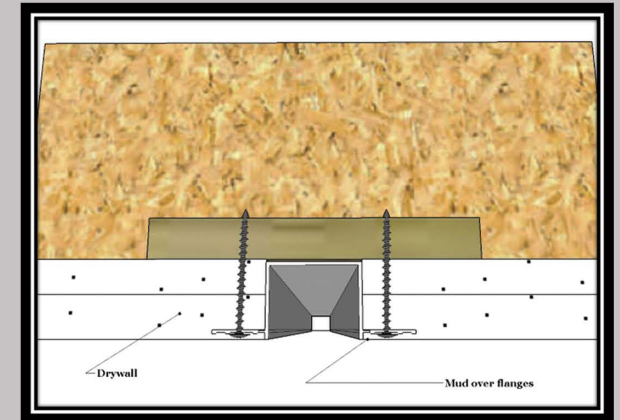

MUD IN HANGER



Introducing the Motorized Solutions Perfect Fit series.

Perfect Fit takes a holistic approach to window treatment concealment. If attention to detail is your pursuit, then Perfect Fit is your solution!

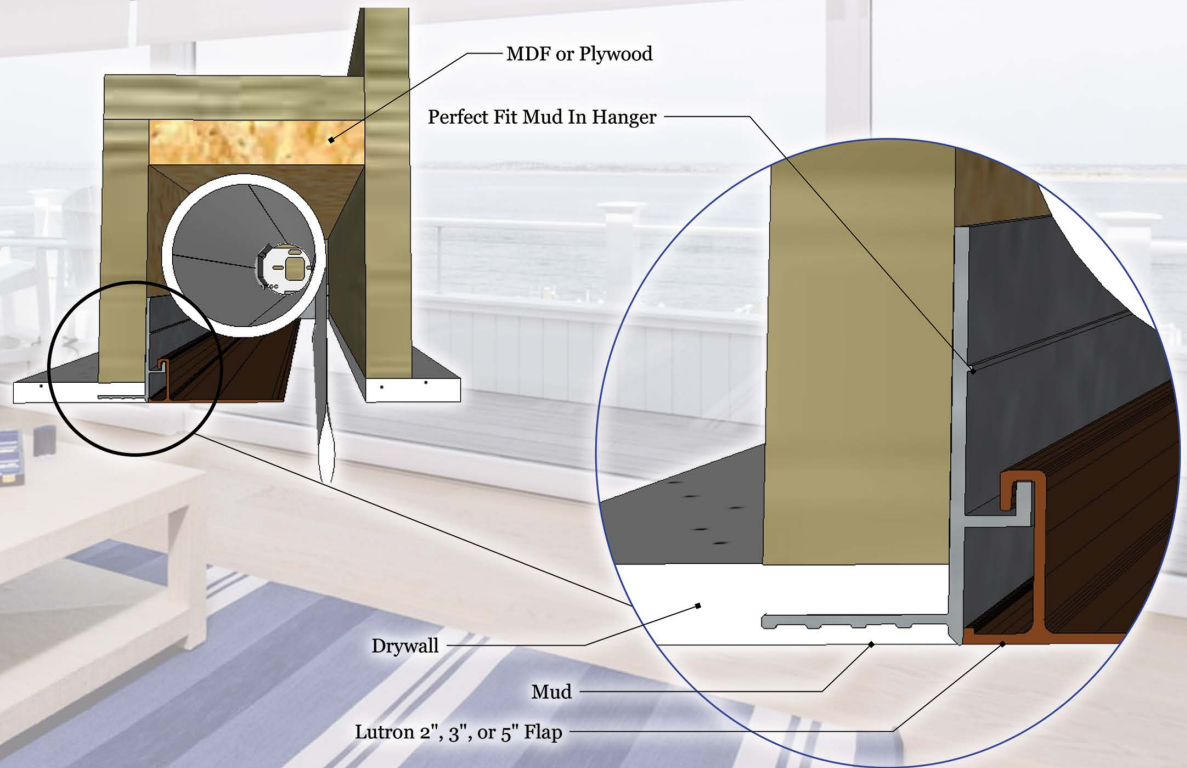

MOTORIZED SOLUTIONS: PARTS



Perfect Fit
Recessed Drapery Track Cavity

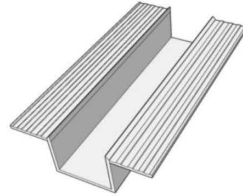

*Seamlessly allows drapery tracks to be recessed into the ceiling

Perfect Fit
Recessed Drapery Track Ends

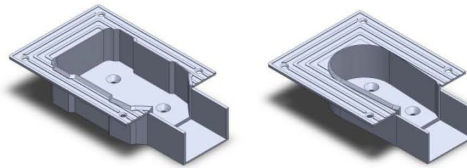

*Motor and idle end for the above

Perfect Fit
Recessed Drapery Track Cavity Bend

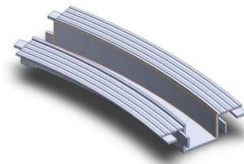

*Radius bend for recessed cavity

Perfect Fit
Bendable Drapery Track Cavity

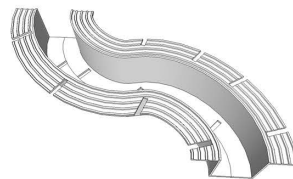

*This is a two-piece bendable Perfect Fit cavity that allows you to create custom curves and bends

MOTORIZED SOLUTIONS: PARTS



Perfect Fit
Mud In Hanger (accepts flap)

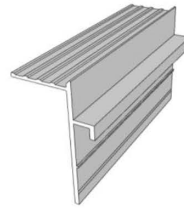

*Creates a perfectly clean line when recessing shades into the ceiling. Eliminates the need for pocket or flap/hanger

Perfect Fit
Mud In Hanger corner

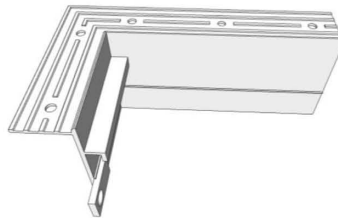

*A perfect 90 degree corner when combined with the above product

Manual drapery track

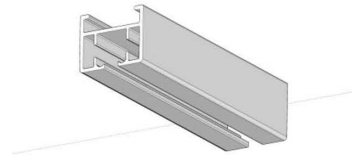

*Manual track for pinch pleat and Ripplefold draperies that closely matches the Lutron drapery track form.

Perfect Fit
Centering Tool

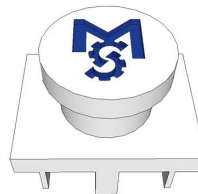

*This tool is used to help center Lutron drapery tracks

MOTORIZED SOLUTIONS: PARTS



Perfect Fit
Dimension Tool

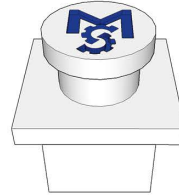

*This tool is used when installing custom curved Perfect Fit cavities to ensure proper spacing for the track.

Bottom-up side channel transition



*Allows the fabric to transition out of the pocket and into the side channel on bottom-up applications

Roman shade tape reel for roller 64
and 100 tube

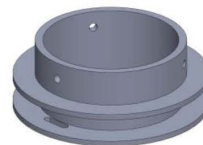

*Tape and safety shroud is also available

Bottom-up flap support



*Supports the pocket flap in bottom-up applications

MOTORIZED SOLUTIONS: PARTS



Palladiom bracket spacer

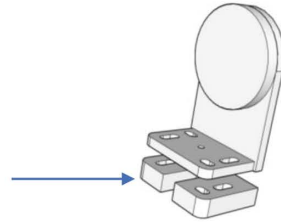

*Used when obstacle clearance is needed but reversed roll is not desired and used in dual Palladiom applications

Spring assembly

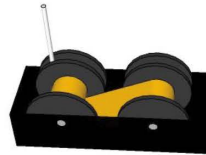

*Constant tension spring units

Spring assembly pocket

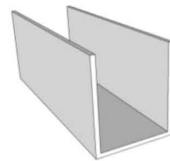

*Pocket for the above



Our MISSION

Motorized Solutions is committed to providing our clients with the most innovative, high-quality automated window treatments in the industry, coupled with a superior customer service experience.

- We are guided by core values that are shared by every member of our team
- We are dedicated to building long-term client relationships
- We will help inspire, educate, and problem solve for our clients
- We value the trust our clients have placed in us and continuously strive to exceed their expectations

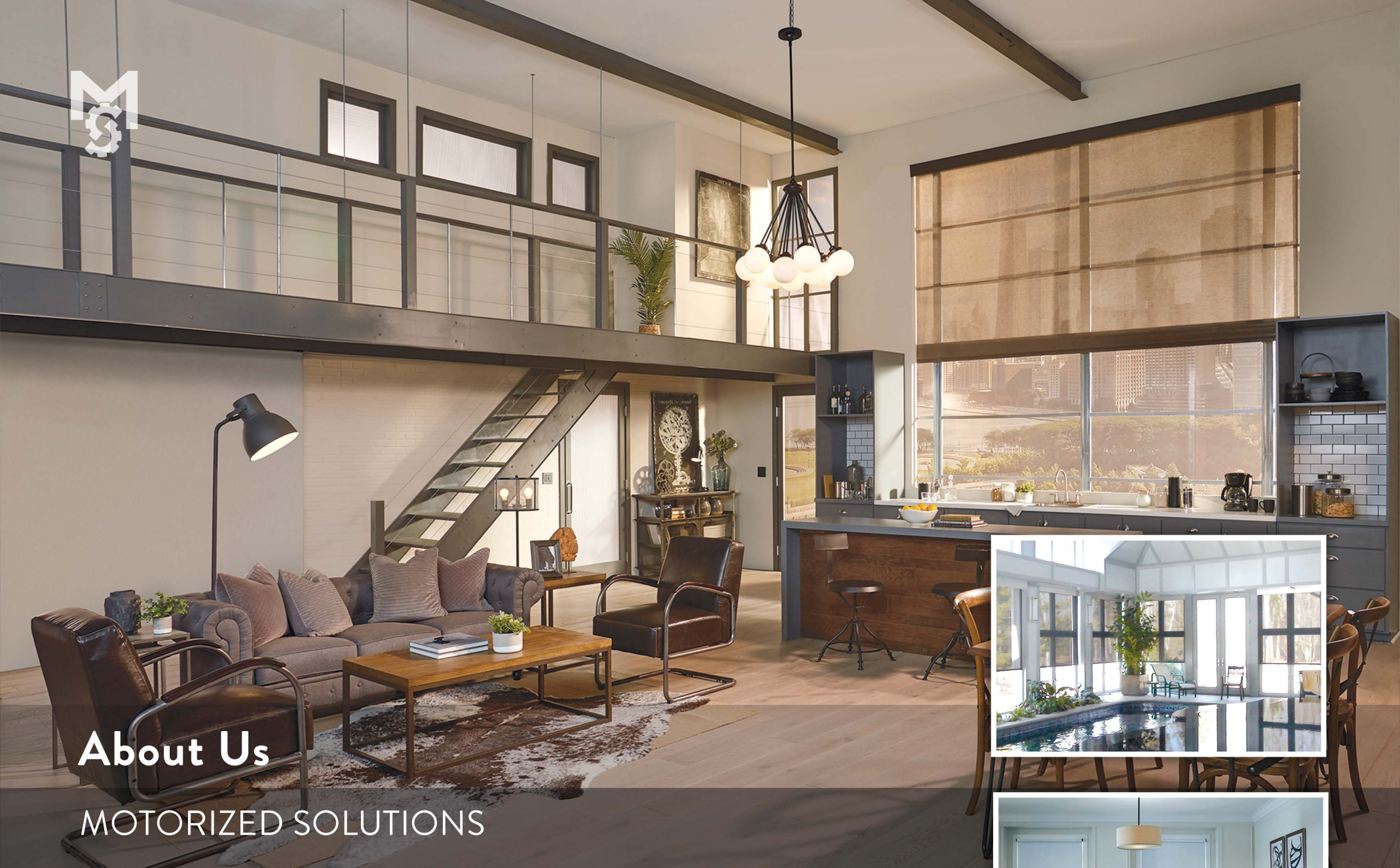

About Us

MOTORIZED SOLUTIONS

Motorized Solutions is proud to offer the most innovative window treatments in the industry since 1976.

Founded in the 1940's as an exclusive custom upholstery company, we have the ingrained passion to perform each project with precision. Our strive for perfection has enabled us to become Lutron's premier residential dealer and the first window treatment dealer inducted into the Lutron Hall of Fame.

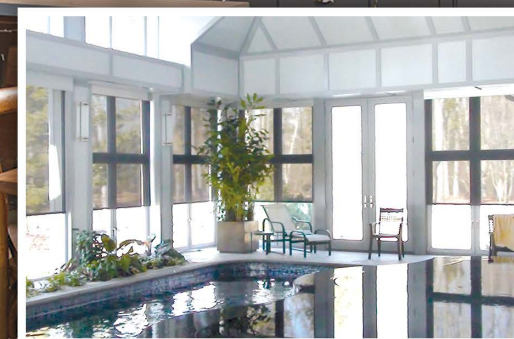

Innovations IN MOTORIZED SOLUTIONS



Motorized Solutions®
Toll Free: 866.446.6867
motorizedsolutions.com
info@motorizedsolutions.com